









MAXPOWER (1500 V) CS6U-315 | 320 | 325 | 330P

Canadian Solar's new 1500 V module is a product for high voltage systems, which can increase the string length of solar systems by up to 50%, saving BOS costs.

KEY FEATURES

-  Designed for high voltage systems of up to 1500 V_{DC}, saving on BoS costs
-  Cell efficiency of up to 18.8 %
-  Excellent module efficiency of up to 16.97 %
-  Outstanding low irradiance performance: 96.0 %
-  High PTC rating of up to 91.55 %
-  IP67 junction box for long-term weather endurance
-  Heavy snow load up to 5400 Pa, wind load up to 2400 Pa



linear power output warranty



product warranty on materials and workmanship

MANAGEMENT SYSTEM CERTIFICATES*

ISO 9001:2008 / Quality management system
ISO 14001:2004 / Standards for environmental management system
OHSAS 18001:2007 / International standards for occupational health & safety

PRODUCT CERTIFICATES*

IEC 61215 / IEC 61730: VDE / CE
UL 1703 / IEC 61215 performance: CEC listed (US)
UL 1703: CSA / IEC 61701 ED2: VDE / IEC 62716: VDE / Take-e-way



* As there are different certification requirements in different markets, please contact your local Canadian Solar sales representative for the specific certificates applicable to the products in the region in which the products are to be used.

CANADIAN SOLAR INC. is committed to providing high quality solar products, solar system solutions and services to customers around the world. As a leading PV project developer and manufacturer of solar modules with over 15 GW deployed around the world since 2001, Canadian Solar Inc. (NASDAQ: CSIQ) is one of the most bankable solar companies worldwide.

CANADIAN SOLAR INC.

545 Speedvale Avenue West, Guelph, Ontario N1K 1E6, Canada, www.canadiansolar.com, support@canadiansolar.com

ENGINEERING DRAWING (mm)

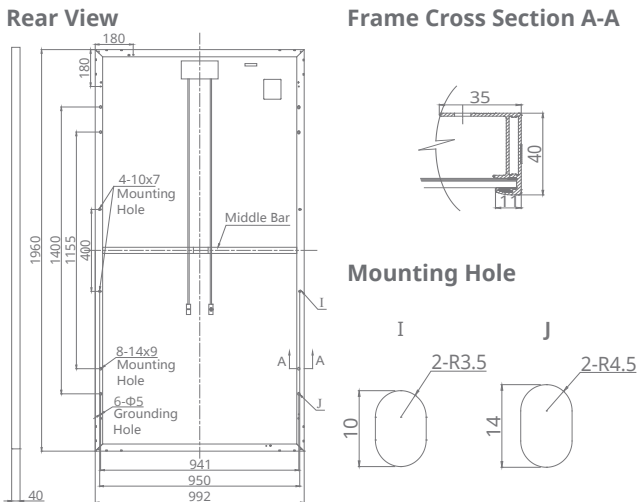

CS6U-320P / I-V CURVES

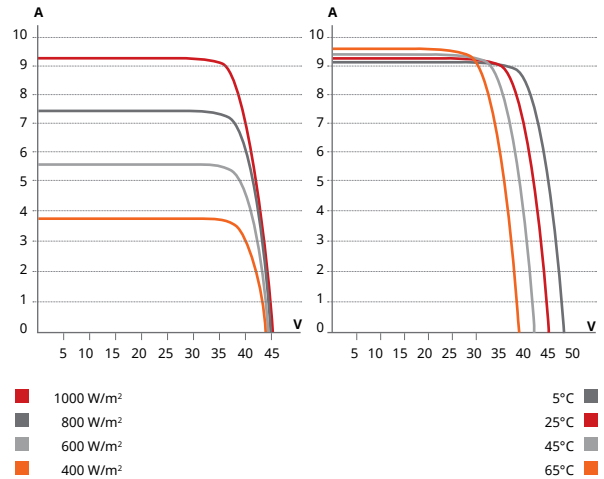

ELECTRICAL DATA | STC*

| CS6U | 315P | 320P | 325P | 330P |
|------------------------------|---|--------|--------|--------|
| Nominal Max. Power (Pmax) | 315 W | 320 W | 325 W | 330 W |
| Opt. Operating Voltage (Vmp) | 36.6 V | 36.8 V | 37.0 V | 37.2 V |
| Opt. Operating Current (Imp) | 8.61 A | 8.69 A | 8.78 A | 8.88 A |
| Open Circuit Voltage (Voc) | 45.1 V | 45.3 V | 45.5 V | 45.6 V |
| Short Circuit Current (Isc) | 9.18 A | 9.26 A | 9.34 A | 9.45 A |
| Module Efficiency | 16.20% | 16.46% | 16.72% | 16.97% |
| Operating Temperature | -40°C ~ +85°C | | | |
| Max. System Voltage | 1500 V (IEC) or 1500 V (UL) | | | |
| Module Fire Performance | TYPE 1 (UL 1703) or CLASS C (IEC 61730) | | | |
| Max. Series Fuse Rating | 15 A | | | |
| Application Classification | Class A | | | |
| Power Tolerance | 0 ~ + 5 W | | | |

* Under Standard Test Conditions (STC) of irradiance of 1000 W/m², spectrum AM 1.5 and cell temperature of 25°C.

MECHANICAL DATA

| Specification | Data |
|------------------------|--|
| Cell Type | Poly-crystalline, 6 inch |
| Cell Arrangement | 72 (6 × 12) |
| Dimensions | 1960 × 992 × 40 mm (77.2 × 39.1 × 1.57 in) |
| Weight | 22.4 kg (49.4 lbs) |
| Front Cover | 3.2 mm tempered glass |
| Frame Material | Anodized aluminium alloy |
| J-Box | IP67, 3 diodes |
| Cable | PV1500DC-F1 4 mm² (IEC) & 12 AWG 2000 V (UL), 1160 mm (45.7 in) |
| Connector | T4 series or PV2 series |
| Per Pallet | 26 pieces, 635 kg (1400 lbs) |
| Per container (40' HQ) | 624 pieces |

ELECTRICAL DATA | NOCT*

| CS6U | 315P | 320P | 325P | 330P |
|------------------------------|--------|--------|--------|--------|
| Nominal Max. Power (Pmax) | 228 W | 232 W | 236 W | 239 W |
| Opt. Operating Voltage (Vmp) | 33.4 V | 33.6 V | 33.7 V | 33.9 V |
| Opt. Operating Current (Imp) | 6.84 A | 6.91 A | 6.98 A | 7.05 A |
| Open Circuit Voltage (Voc) | 41.5 V | 41.6 V | 41.8 V | 41.9 V |
| Short Circuit Current (Isc) | 7.44 A | 7.50 A | 7.57 A | 7.66 A |

* Under Nominal Operating Cell Temperature (NOCT), irradiance of 800 W/m², spectrum AM 1.5, ambient temperature 20°C, wind speed 1 m/s.

TEMPERATURE CHARACTERISTICS

| Specification | Data |
|------------------------------------|--------------|
| Temperature Coefficient (Pmax) | -0.41 % / °C |
| Temperature Coefficient (Voc) | -0.31 % / °C |
| Temperature Coefficient (Isc) | 0.053 % / °C |
| Nominal Operating Cell Temperature | 45±2 °C |

PERFORMANCE AT LOW IRRADIANCE

Outstanding performance at low irradiance, average relative efficiency of 96.0 % from an irradiance of 1000 W/m² to 200 W/m² (AM 1.5, 25°C).

The specification and key features described in this datasheet may deviate slightly and are not guaranteed. Due to on-going innovation, research and product enhancement, Canadian Solar Inc. reserves the right to make any adjustment to the information described herein at any time without notice. Please always obtain the most recent version of the datasheet which shall be duly incorporated into the binding contract made by the parties governing all transactions related to the purchase and sale of the products described herein.

Caution: For professional use only. The installation and handling of PV modules requires professional skills and should only be performed by qualified professionals. Please read the safety and installation instructions before using the modules.

PARTNER SECTION

